



**DOMIproject C32**

LISTA PEZZI DI RICAMBIO

SPARE PART LIST

ERSATZSTEILE

LIJST ONDERDELEN

LISTE PIECES DETACHES

LISTA PIEZAS DE REPUESTO

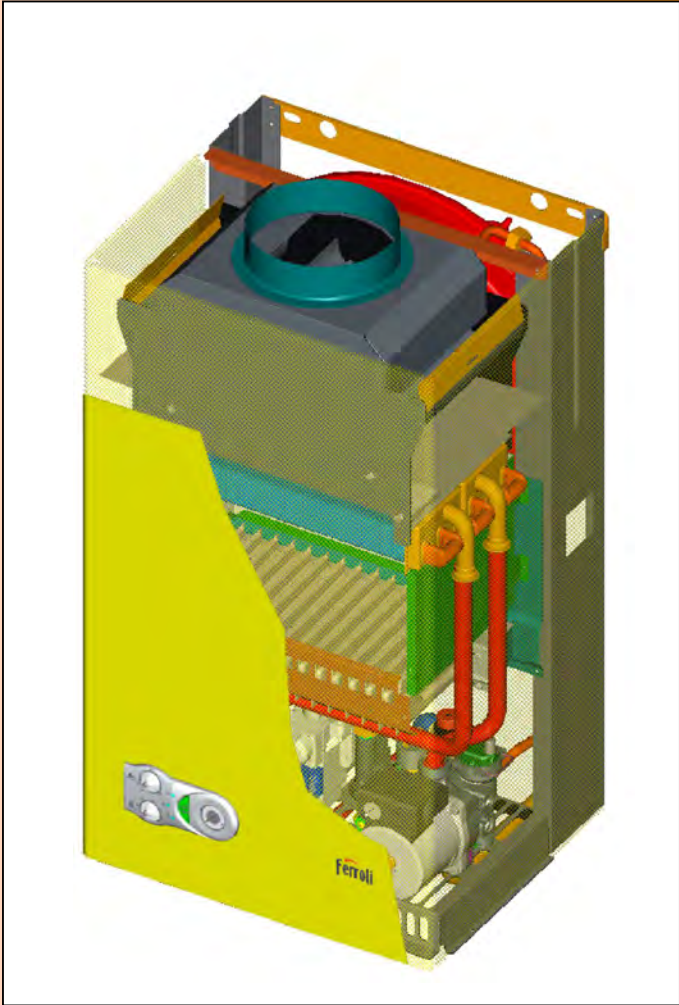

<b>CODICE</b>	<b>EDIZIONE</b>	<b>MERCATO</b>
<b>30K0287000</b>	<b>22/03/2006</b>	<b>A2-A3-A4-A5</b>

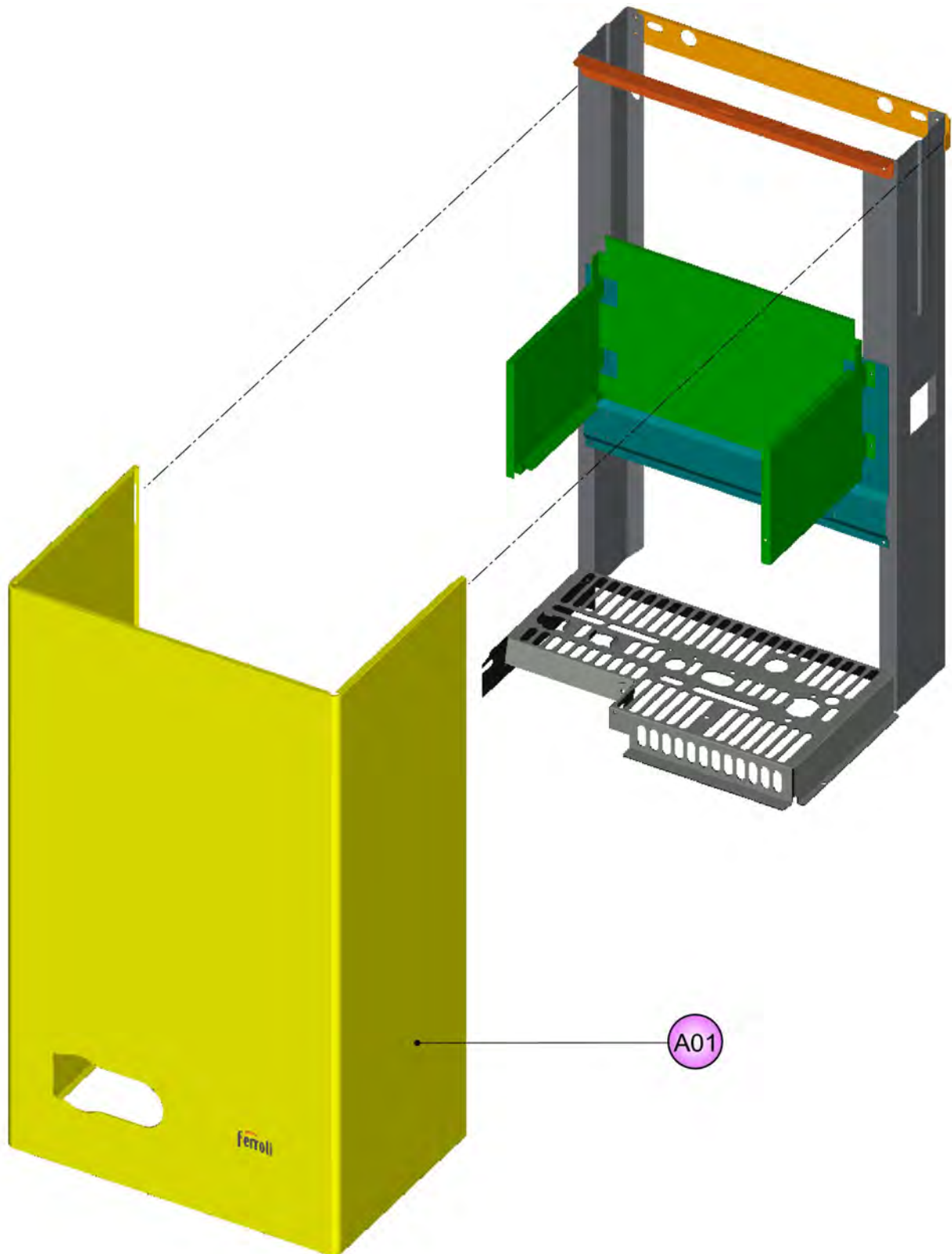

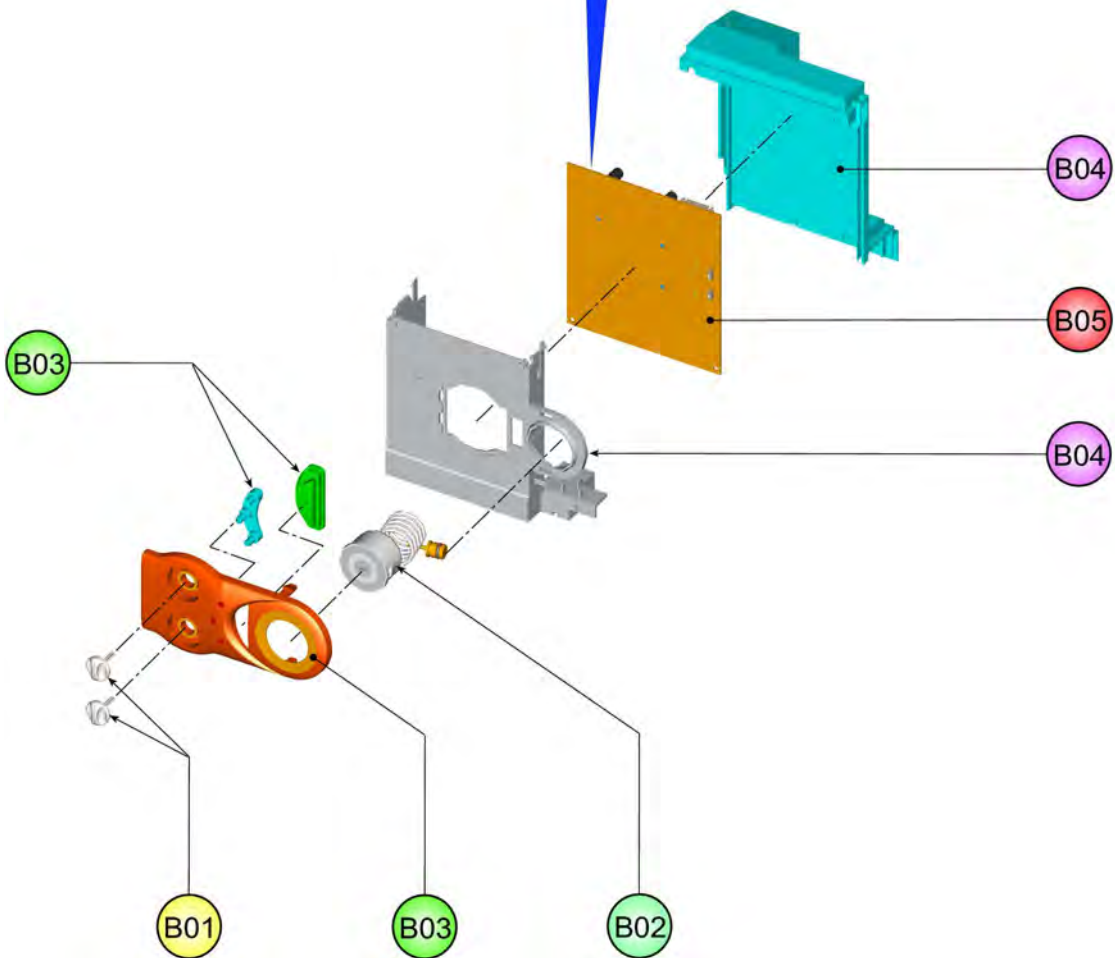
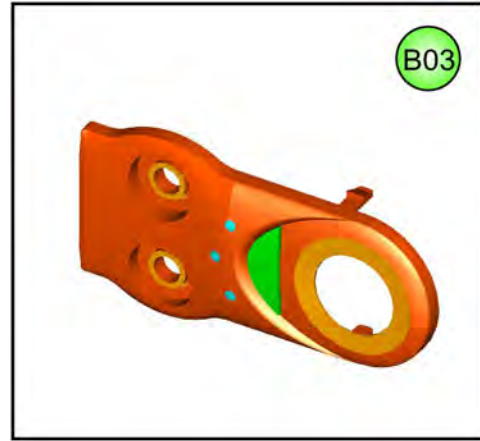
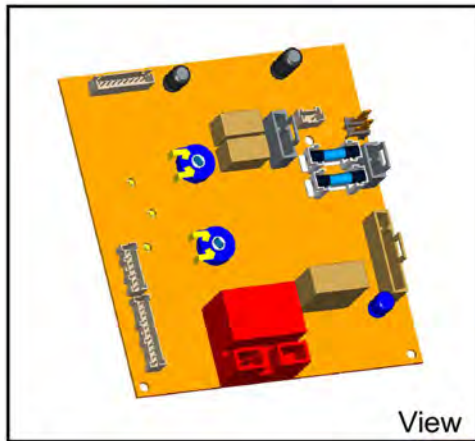

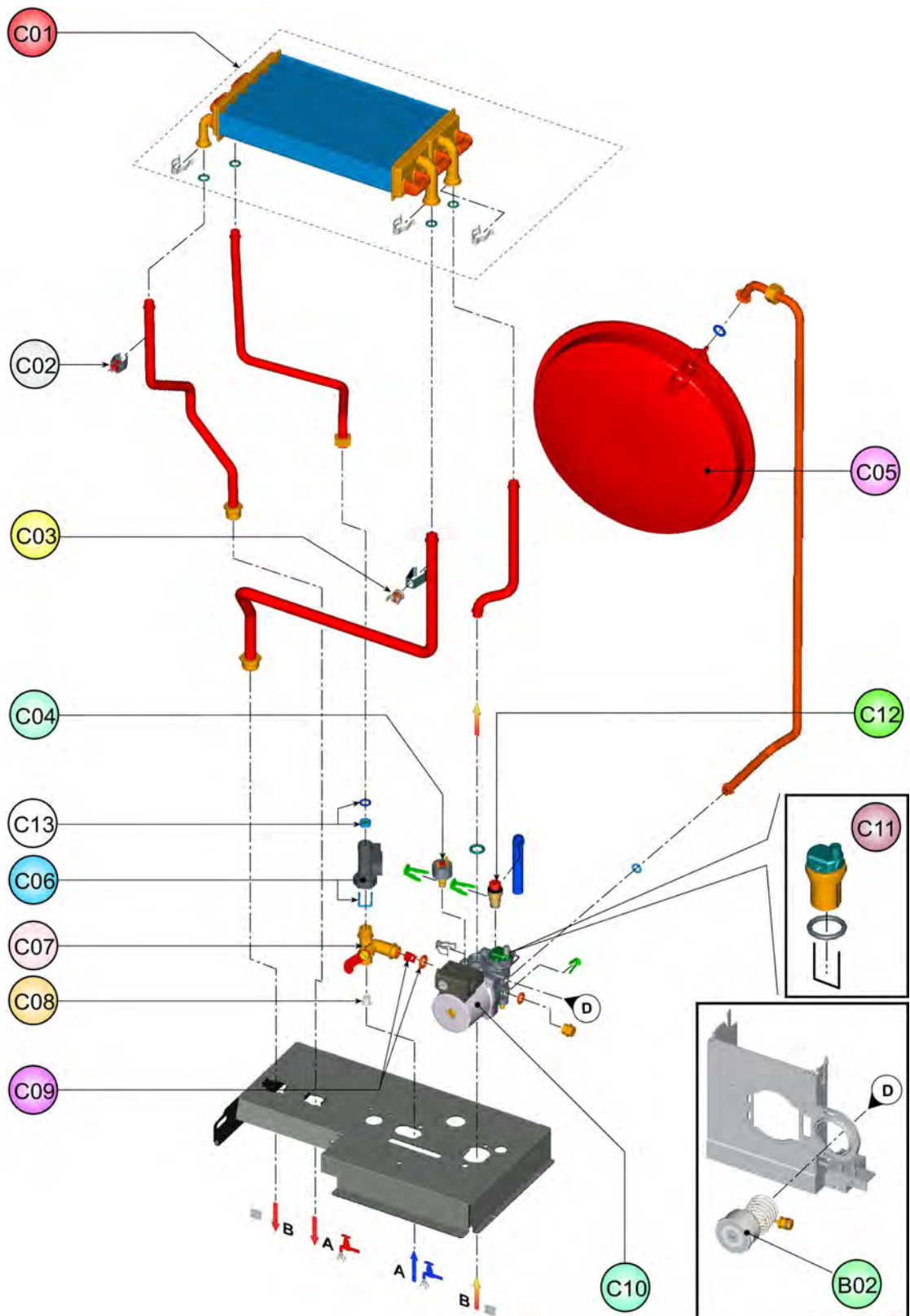

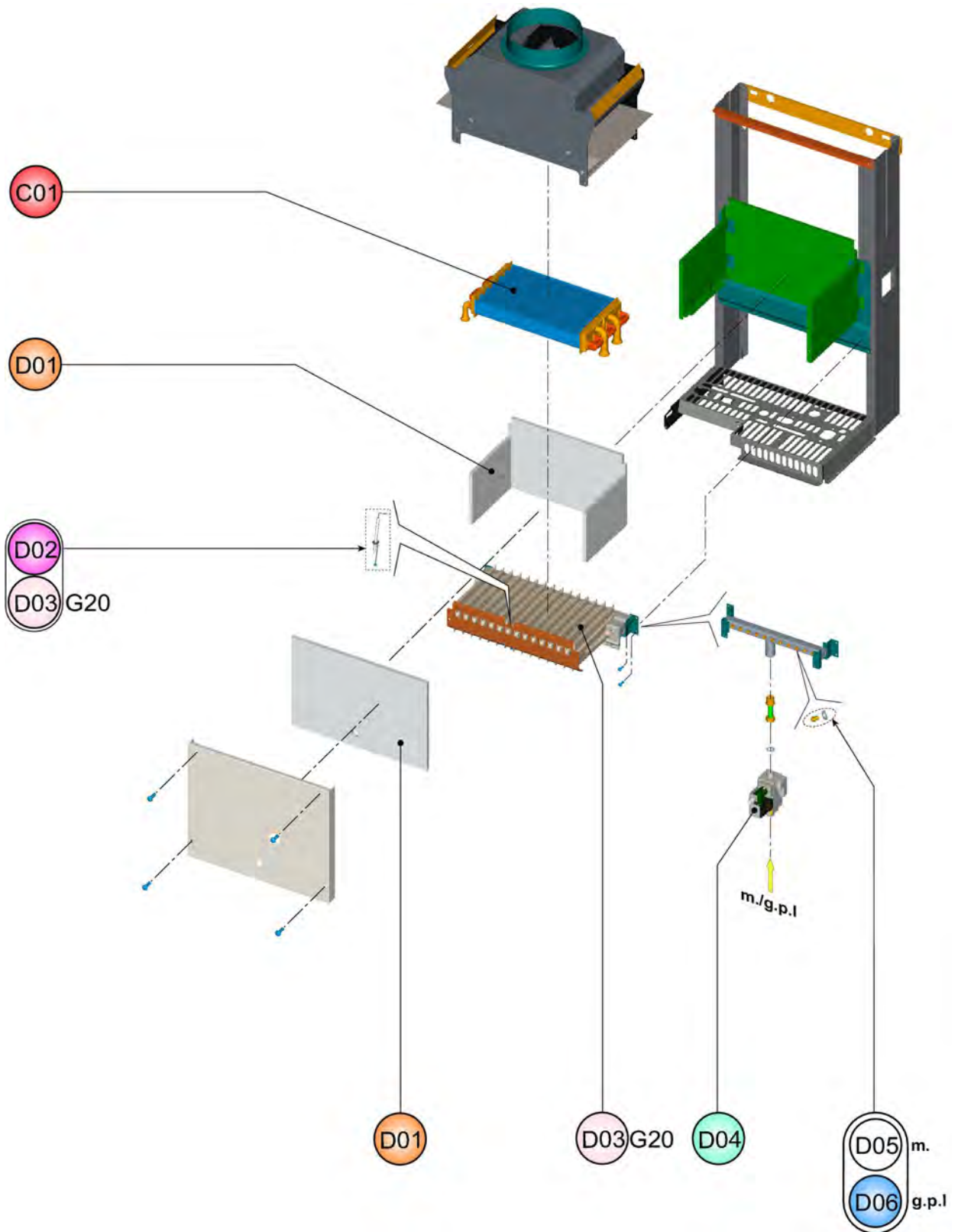

<b>LISTA PEZZI 0ABC7B2A</b>		<b>DOMIproject C32 m. (A2)</b>	
<b>POS.</b>	<b>CODICE</b>	<b>DESC.</b>	<b>QT.</b>
A01	39819660	KIT MANTELLO (31115970)	1
B01	39819500	KIT 2 MANOPOLE (35012090)	1
B02	39818210	KIT IDROMETRO (36402070)	1
B03	39819510	KIT MASCHERINA (35011990)	1
B04	39819520	KIT SCATOLA EL. (35012240)	1
B05	39819530	KIT SCHEDA EL. (36507990)	1
C01	39819910	KIT SCAMB.BITERM. (37404310)	1
C02	39819550	KIT SONDA TEMP. (36200730)	1
C03	39810230	KIT SONDA TEMP.SAN. (36200640)	1
C04	39818260	KIT PRESSOST.H2O (39404710)	1
C05	39809690	KIT VASO ESP.10Lt. (36802740)	1
C06	39818550	KIT FLUSSOST.ELTEK (36400710)	1
C07	39818280	KIT RUBIN.CARICO (36902150)	1
C08	39813230	KIT 5 FILTRI FLUSS. (39402940)	1
C09	39818230	KIT 5 VALV.N/R (39404740)	1
C10	39818450	KIT POMPA AO/FX3FPL (39404220)	1
C11	39818220	KIT V.ARIA (39404380-39404730)	1
C12	39818270	KIT VALV.SIC. (39404720)	1
C13	39813220	KIT 5 REG.PORT.15Lt. (36902100)	1
D01	39819720	KIT ISOL.CAM.COMB. Sr.ABF7	1
D02	39819430	KIT ELETTRODO ACC. (36702890)	1
D03	39819730	KIT BRUC.15R.m. (37608930)	1
D04	39819620	KIT VALV.GAS (36800610)	1
D05	39819700	KIT 15 UG.1,35 m. (34009821)	1

<b>LISTA PEZZI 0ABC7B3A</b>		<b>DOMIproject C32 m. (A3)</b>	
<b>POS.</b>	<b>CODICE</b>	<b>DESC.</b>	<b>QT.</b>
A01	39819660	KIT MANTELLO (31115970)	1
B01	39819500	KIT 2 MANOPOLE (35012090)	1
B02	39818210	KIT IDROMETRO (36402070)	1
B03	39819510	KIT MASCHERINA (35011990)	1
B04	39819520	KIT SCATOLA EL. (35012240)	1
B05	39819530	KIT SCHEDA EL. (36507990)	1
C01	39819910	KIT SCAMB.BITERM. (37404310)	1
C02	39819550	KIT SONDA TEMP. (36200730)	1
C03	39810230	KIT SONDA TEMP.SAN. (36200640)	1
C04	39818260	KIT PRESSOST.H2O (39404710)	1
C05	39809690	KIT VASO ESP.10Lt. (36802740)	1
C06	39818550	KIT FLUSSOST.ELTEK (36400710)	1
C07	39818280	KIT RUBIN.CARICO (36902150)	1
C08	39813230	KIT 5 FILTRI FLUSS. (39402940)	1
C09	39818230	KIT 5 VALV.N/R (39404740)	1
C10	39818450	KIT POMPA AO/FX3FPL (39404220)	1
C11	39818220	KIT V.ARIA (39404380-39404730)	1
C12	39818270	KIT VALV.SIC. (39404720)	1
C13	39813220	KIT 5 REG.PORT.15Lt. (36902100)	1
D01	39819720	KIT ISOL.CAM.COMB. Sr.ABF7	1
D02	39819430	KIT ELETTRODO ACC. (36702890)	1
D03	39819730	KIT BRUC.15R.m. (37608930)	1
D04	39819620	KIT VALV.GAS (36800610)	1
D05	39819700	KIT 15 UG.1,35 m. (34009821)	1

<b>LISTA PEZZI 0ABC7B4A</b>		<b>DOMIproject C32 m. (A4)</b>	
<b>POS.</b>	<b>CODICE</b>	<b>DESC.</b>	<b>QT.</b>
A01	39819660	KIT MANTELLO (31115970)	1
B01	39819500	KIT 2 MANOPOLE (35012090)	1
B02	39818210	KIT IDROMETRO (36402070)	1
B03	39819510	KIT MASCHERINA (35011990)	1
B04	39819520	KIT SCATOLA EL. (35012240)	1
B05	39819530	KIT SCHEDA EL. (36507990)	1
C01	39819910	KIT SCAMB.BITERM. (37404310)	1
C02	39819550	KIT SONDA TEMP. (36200730)	1
C03	39810230	KIT SONDA TEMP.SAN. (36200640)	1
C04	39818260	KIT PRESSOST.H2O (39404710)	1
C05	39809690	KIT VASO ESP.10Lt. (36802740)	1
C06	39818550	KIT FLUSSOST.ELTEK (36400710)	1
C07	39818280	KIT RUBIN.CARICO (36902150)	1
C08	39813230	KIT 5 FILTRI FLUSS. (39402940)	1
C09	39818230	KIT 5 VALV.N/R (39404740)	1
C10	39818450	KIT POMPA AO/FX3FPL (39404220)	1
C11	39818220	KIT V.ARIA (39404380-39404730)	1
C12	39818270	KIT VALV.SIC. (39404720)	1
C13	39813220	KIT 5 REG.PORT.15Lt. (36902100)	1
D01	39819720	KIT ISOL.CAM.COMB. Sr.ABF7	1
D02	39819430	KIT ELETTRODO ACC. (36702890)	1
D03	39819730	KIT BRUC.15R.m. (37608930)	1
D04	39819620	KIT VALV.GAS (36800610)	1
D05	39819700	KIT 15 UG.1,35 m. (34009821)	1



<b>LISTA PEZZI 0ABC7B5A</b>		<b>DOMIproject C32 m. (A5)</b>	
<b>POS.</b>	<b>CODICE</b>	<b>DESC.</b>	<b>QT.</b>
A01	39819660	KIT MANTELLO (31115970)	1
B01	39819500	KIT 2 MANOPOLE (35012090)	1
B02	39818210	KIT IDROMETRO (36402070)	1
B03	39819510	KIT MASCHERINA (35011990)	1
B04	39819520	KIT SCATOLA EL. (35012240)	1
B05	39819530	KIT SCHEDA EL. (36507990)	1
C01	39819910	KIT SCAMB.BITERM. (37404310)	1
C02	39819550	KIT SONDA TEMP. (36200730)	1
C03	39810230	KIT SONDA TEMP.SAN. (36200640)	1
C04	39818260	KIT PRESSOST.H2O (39404710)	1
C05	39809690	KIT VASO ESP.10Lt. (36802740)	1
C06	39818550	KIT FLUSSOST.ELTEK (36400710)	1
C07	39818280	KIT RUBIN.CARICO (36902150)	1
C08	39813230	KIT 5 FILTRI FLUSS. (39402940)	1
C09	39818230	KIT 5 VALV.N/R (39404740)	1
C10	39818450	KIT POMPA AO/FX3FPL (39404220)	1
C11	39818220	KIT V.ARIA (39404380-39404730)	1
C12	39818270	KIT VALV.SIC. (39404720)	1
C13	39813220	KIT 5 REG.PORT.15Lt. (36902100)	1
D01	39819720	KIT ISOL.CAM.COMB. Sr.ABF7	1
D02	39819430	KIT ELETTRODO ACC. (36702890)	1
D03	39819730	KIT BRUC.15R.m. (37608930)	1
D04	39819620	KIT VALV.GAS (36800610)	1
D05	39819700	KIT 15 UG.1,35 m. (34009821)	1

<b>LISTA PEZZI 0ABC7D2A</b>		<b>DOMIproject C32 gpl (A2)</b>	
<b>POS.</b>	<b>CODICE</b>	<b>DESC.</b>	<b>QT.</b>
A01	39819660	KIT MANTELLO (31115970)	1
B01	39819500	KIT 2 MANOPOLE (35012090)	1
B02	39818210	KIT IDROMETRO (36402070)	1
B03	39819510	KIT MASCHERINA (35011990)	1
B04	39819520	KIT SCATOLA EL. (35012240)	1
B05	39819530	KIT SCHEDA EL. (36507990)	1
C01	39819910	KIT SCAMB.BITERM. (37404310)	1
C02	39819550	KIT SONDA TEMP. (36200730)	1
C03	39810230	KIT SONDA TEMP.SAN. (36200640)	1
C04	39818260	KIT PRESSOST.H2O (39404710)	1
C05	39809690	KIT VASO ESP.10Lt. (36802740)	1
C06	39818550	KIT FLUSSOST.ELTEK (36400710)	1
C07	39818280	KIT RUBIN.CARICO (36902150)	1
C08	39813230	KIT 5 FILTRI FLUSS. (39402940)	1
C09	39818230	KIT 5 VALV.N/R (39404740)	1
C10	39818450	KIT POMPA AO/FX3FPL (39404220)	1
C11	39818220	KIT V.ARIA (39404380-39404730)	1
C12	39818270	KIT VALV.SIC. (39404720)	1
C13	39813220	KIT 5 REG.PORT.15Lt. (36902100)	1
D01	39819720	KIT ISOL.CAM.COMB. Sr.ABF7	1
D02	39819430	KIT ELETTRODO ACC. (36702890)	1
D04	39819620	KIT VALV.GAS (36800610)	1
D06	39819710	KIT 15 UG.0,79 gpl (34013300)	1

Firma  
DI CARLO Cristian